

esenzia 3.5

esenzia 3.5

dormitorios · armarios





esenzia 3.5

Dormitorios · Armarios / Bedrooms · Wardrobes / Chambres · Armoires

Vives nuevos tiempos. Compartes nuevos estilos de vida. Eliges nuevas formas de ser, divertírte, diferenciarte, relacionarte, y expresarte. Descubres nuevas maneras de organizar tu entorno. Tu espacio refleja tu forma de ser y de vivir, lo que te rodea dice mucho de ti, por todo ello hemos creado una nueva colección Esenzia 3.5, una nuevo catálogo de dormitorios y armarios que Baixmoduls ha pensado para encajar en tu forma de vida, con propuestas estéticas de nueva actualidad y un espíritu totalmente funcional, siguiendo las últimas tendencias en acabados y colores; pero con la elegancia y calidad de un estilo propio. Con formas que invitan a disfrutar del entorno que lo hacen único, pensado para sacar el máximo partido de tu espacio y diseñado para llenarlo de belleza. Aquí encontraras todo tipo de opciones para dar un toque personal a tu hogar: variado, confortable, completo: muy especial. Ven a conocer un conjunto de ambientes creados para un estilo de vida moderno. Crea tu propio espacio.

-
You are living in a new era. You have different lifestyles. You choose new ways to live, enjoy yourself, meet people, to express yourself. You discover new ways of arranging your surroundings. Your home reflects your lifestyle, what's around you, says lots about you, for all of this we have created a new Esenzia 3.5 collection, a new catalog of bedrooms and wardrobes that Baixmoduls has thought to fit into your way of life, with new aesthetic proposals and a fully functional spirit, following the latest trends in finishes and colours; but with the elegance and quality of a style of its own. With shapes that invite you to enjoy your surroundings and details that make it unique, designed to make the most of your space and designed to fill it with beauty. Here you will find all kinds of options to give a personal touch to your home: varied, comfortable, complete: very special. Come and meet a set of ambiants created for a modern lifestyle. Create your own space.

-
Vous vivez de nouveaux moments. Vous partagez de nouveaux modes de vie. Vous choisissez de nouvelles façons d'être, de vous amuser, de vous différencier, de vous relier et de vous exprimer. Découvrez de nouvelles façons d'organiser votre environnement. Votre espace reflète votre façon d'être et de vivre, autour de vous en dit beaucoup sur vous, pour tout ce que nous avons créé une nouvelle collection Esenzia 3.5, un nouveau catalogue de chambres et armoires Baixmoduls pensé à intégrer dans votre style de vie, avec de nouvelles propositions esthétiques et un esprit entièrement fonctionnel, suivant les dernières tendances en matière de finitions et de couleurs; mais avec l'élégance et la qualité d'un style qui lui est propre. Avec des formes qui vous invitent à profiter de l'environnement qui le rend unique, conçu pour tirer le meilleur parti de votre espace et conçu pour le remplir de beauté. Ici vous trouverez toutes sortes d'options pour donner une touche personnelle à votre maison : variée, confortable, complète : très spéciale. Venez rencontrer un ensemble d'ambiances créés pour un style de vie moderne. Créez votre propre espace.

Calidades y Diferenciación

Qualities and differentiation / Qualités et différenciation



Cabezales con encaste para rodapié

Headboard with adjust for the plinth / Tête de lit avec ajustement pour le socle

Todos los cabezales adaptados de serie con encaste para rodapié.

- All headboards adapt as standard with adjust for the plinth. / Toutes les têtes de lit s'adaptent de forme standard avec ajustement pour le socle.



Armarios puertas batientes

Wardrobes / Armoires portes battantes

Con 5 bisagras de acero por puerta, regulables y con sistema de cierre de retención.

- With 5 steel hinges per door, adjustable and with locking system. / Avec 5 charnières en acier par porte, réglable et avec système de verrouillage.



Armarios puertas correderas

Wardrobes Sliding doors / Armoires portes coulissantes

Con 2 frenos por puerta para un cierre suave, fiable y seguro.

- With 2 brakes per door for a soft, reliable and safe closing. / Avec 2 freins par porte pour une fermeture douce, fiable et sûre.

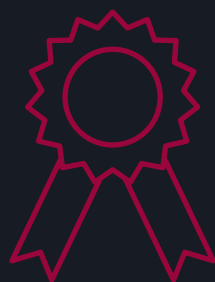

Nuestra dedicación y constante evolución en el sector del mueble nos ha permitido crear un producto con colores más actuales y materiales de primera calidad. Nuestros tableros melamínicos cumplen con la normativa de gestión forestal sostenible.

Our dedication and constant evolution in the furniture sector has allowed us to create a product with more current colors and top quality materials. Our melamine boards comply with the regulations of sustainable forest management.

- Notre dévouement et notre constante évolution dans le secteur du meuble nous ont permis de créer un produit avec des couleurs plus actuelles et des matériaux de qualité supérieure. Nos panneaux de mélamine sont conformes à la réglementation de la gestion durable des forêts.



Sistema frenado

Braking system / Système de freinage

Todos los cajones y cajoneras interiores llevan sistema de auto-cierre con freno.

- All interior drawers and chest of drawers have self-closing system with brake. / Tous les tiroirs et tiroirs intérieurs ont un système de fermeture automatique avec frein.



Adaptable a medida

Customizable / Personnalisable

Gran variedad de medidas de armario adaptables a cualquier espacio.

- Wide variety of wardrobe measures adaptable to any space. / Grande variété de mesures d'armoire adaptables à n'importe quel espace.



Armarios resistentes

Resistant wardrobes / Armoires résistantes

Las cajas son individuales para facilitar el montaje y obtener una mejor resistencia y durabilidad. Traseras de 10mm que aportan resistencia y fiabilidad al armario.

- The boxes are individual to facilitate assembly and obtain better strength and durability. The back are of 10mm that provide resistance and reliability to the wardrobe. / Les boîtes sont individuelles pour faciliter le montage et obtenir une meilleure résistance et durabilité. Le dos est de 10mm qui fournissent la résistance et la fiabilité à l'armoire.



Detalles metálicos de color

Metallic details with colour / Détails métalliques avec couleur

Disponemos de dos colores diferentes (Blanco y Zafiro) para todos los complementos metálicos.

- We have two different colours (Blanco and Zafiro) for all metal accessories. / Nous avons deux couleurs différentes (Blanco et Zafiro) pour tous les accessoires en métal.



LED Sistema de iluminación

LED Lighting system / Système d'éclairage LED

Todas las luces son LED, disponen de interruptor encendido y apagado, así se obtiene una mayor eficiencia energética.

- All the lights are LED, they have switch on/off, this way you get a higher energy efficiency. / Toutes les lumières sont LED, ils ont un interrupteur, de cette façon vous obtenez une plus grande efficacité énergétique.



Flexo luz con cargador USB

Reading lamp with USB charger / Lampe lumière avec Chargeur USB

La luz es LED e incorpora un cargador USB. El cargador está homologado para cargar todo tipo de dispositivos.

- The Reading Lamp is LED light and incorporate an USB charger. The charger is approved to charge all type of devices. / Lampe LED avec chargeur USB. Le chargeur est approuvé pour charger tous les types d'appareils.



Mesitas con aristas ingletadas

Bedsides with mitered edges / Chevets avec des bords en onglet

Esta nueva forma aporta diferenciación, elegancia y diseño al mueble.

- This new model brings differentiation, elegance and design to the furniture. / Cette nouvelle forme apporte différenciation, élégance et design au meuble.



Grosos de tablero

Board thicknesses / Épaisseurs de panneau

Trabajamos con grosores de 19mm y 40mm en todos nuestros productos.

- We work with thicknesses of 19mm and 40mm in all our products. / Nous travaillons avec des épaisseurs de 19mm et 40mm dans tous nos produits.



Sistemas ergonómicos

Ergonomic systems / Systèmes ergonomiques

Canapé con 3 posiciones diferentes: abierto, cerrado o en posición ergonómica para hacer la cama.

- Storage-bed with 3 different positions: open, closed or in an ergonomic position to make the bed. / Canapé avec 3 positions différentes : ouvert, fermé ou dans une position ergonomique pour faire le lit.



Gran variedad de mesitas

Big variety of bedsides / Grande variété de chevets

Disponemos de cinco modelos distintos de mesitas.

- We have five different models of bedsides. / Nous avons cinq modèles différents de chevets.

Colores

Colours / Couleurs



K01 BLANCO WHITE



K03 BORNEO



K05 ROBLE ROCK



K11 AVELLANA



K13 VERDE TÉ



K02 FRESNO



K04 BAMBÚ



K06 TEKA



K12 GRIS FUMÉ



K14 AZUL MANHATTAN

Metálicos

Metals / Métals



K20 ZAFIRO

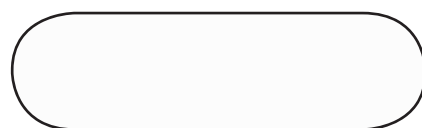

K21 BLANCO

Colores

Colours / Couleurs



A01 BLANCO SEDA



A03 BAMBÚ



A05 NATURE



A07 PETRA



A11 AVELLANA



A02 NORDIC



A04 ROBLE ROCK



A06 ZINC



A08 ÓNIX



A12 GRIS FUMÉ

Combina el color zinc con el ónix y crea un ambiente muy fresco. Siempre hay sitio para la creatividad, el color y el estilo

It combines the zinc colour with the ónix tone and creates a very fresh atmosphere. There is always room for creativity, colour and style.

Combine la couleur zinc avec l'ónix et crée une atmosphère très fraîche. Il y a toujours de la place pour la créativité, la couleur et le style.

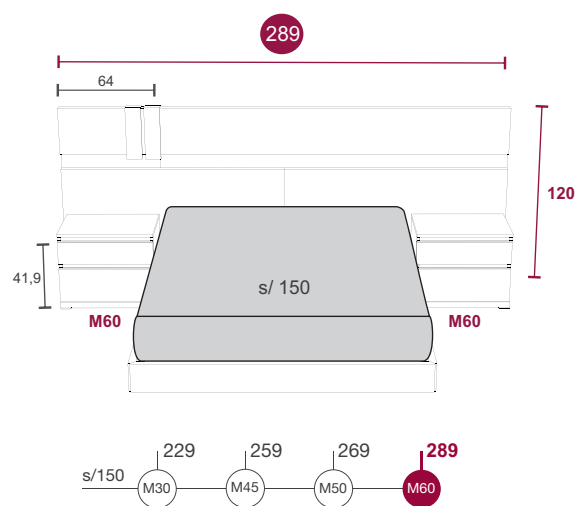

Color
Colour/Couleur

A06

Zinc



Detalle
Detail/Détail

A08

Ónix

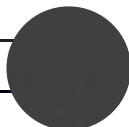

Metálico
Metal/Métallique

K20

Zafiro



E171



AR51





Un armario de seis puertas batientes con dos puertas de cristal que hacen el armario muy elegante.

A wardrobe with six doors with two glass doors that make the wardrobe very elegant.

-
Une armoire à six portes battantes avec deux portes vitrées qui rendent l'armoire très élégante.

OPCIONAL:

TIRAS LED PARA INTERIOR DE CAJAS DE ARMARIO:

x1 TIRA	LED /CAJA	205 Puntos
x2 TIRAS	LED /CAJA	290 Puntos

PUERTAS CON PERFIL DE ALUMINIO - CRISTAL TEMPLADO:

x1 PTA	CRISTAL PARSOL TEMPLADO	400 Puntos
x2 PTAS	CRISTAL PARSOL TEMPLADO	800 Puntos

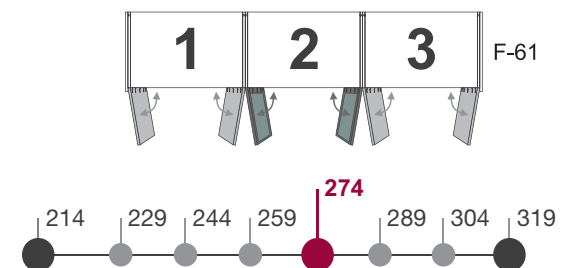

Color
Colour/Couleur
A06
Zinc



Metálico
Metal/Métallique
A20
Ónix

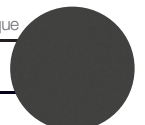

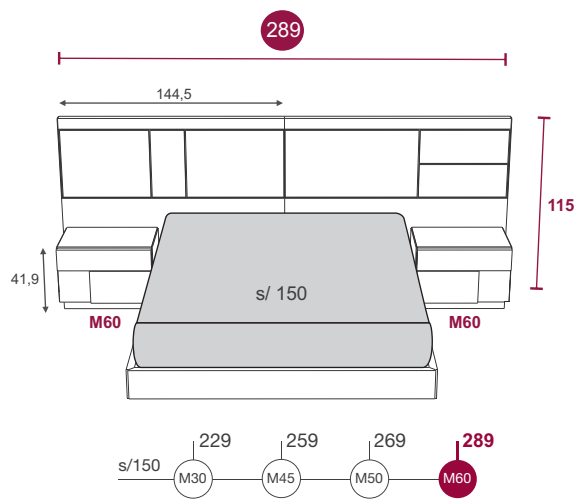

Color
Colour/Couleur

A01
Blanco
Seda

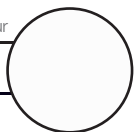

Detalle 1
Colour/Couleur

A06
Zinc



Detalle 2
Detail/Détail

A08
Ónix

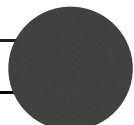

E172



E173





Nordic, un color natural que combinado con el blanco seda inspira un dormitorio totalmente escandinavo.

Nordic, a natural colour that combined with blanco seda inspires a totally Scandinavian bedroom.

Nordic, une couleur naturelle laquelle combinée avec le blanco seda inspire une chambre totalement scandinave.

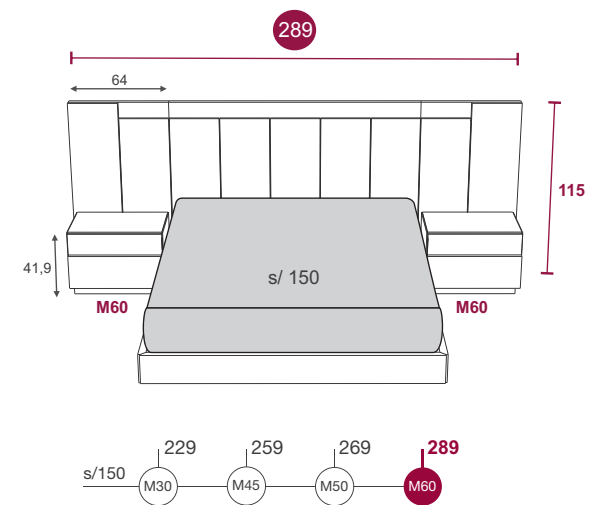

Color
Colour/Couleur
A02
Nordic

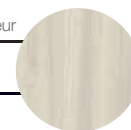

Detalle
Detail/Détail
A01
Blanco Seda

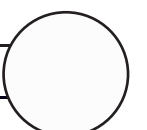

Calidez, diseño y funcionalidad. Un espacio luminoso donde el orden está muy presente.

Warmth, design and functionality. A bright space where order is present.

Chaleur, design et fonctionnalité. Un espace lumineux où l'ordre est très présent.

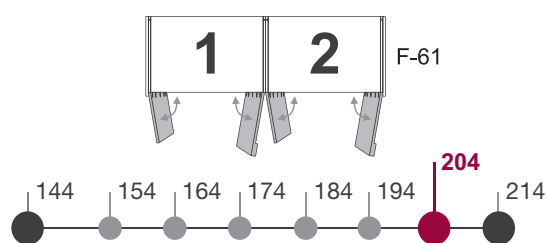

Color

Colour/Couleur

A02

Nordic



Detalle

Detail/Détail

A01

Blanco
Seda

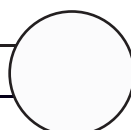

AR52



Un balance perfecto entre diferentes opciones de acabados y tamaños.

La colección permite adaptar los muebles a tu espacio.

A perfect balance between different options of finishes and sizes. The collection allows you to adapt the furniture to your space.

Un équilibre parfait entre différentes options de finitions et de tailles. La collection vous permet d'adapter le mobilier à votre espace.

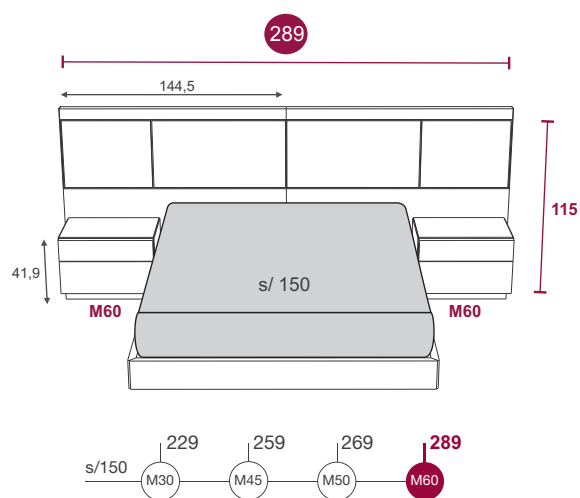

Color
Colour/Couleur

A05

Nature



Detalle
Detail/Détail

A08

Ónix

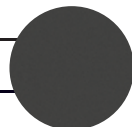

E174



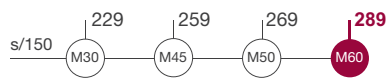
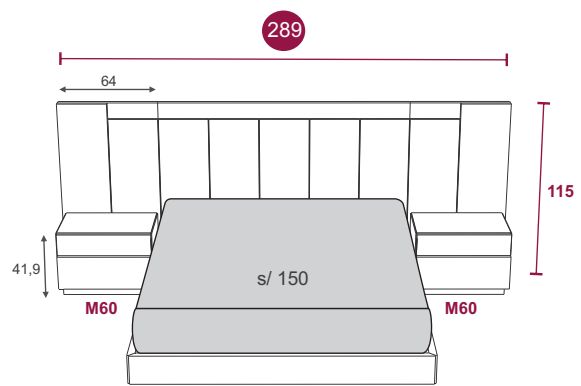

Color
Colour/Couleur

A05

Nature



Detalle
Detail/Détail

A08

Ónix

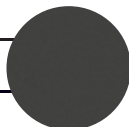

E175



AR53





Descubre las nuevas tendencias en orden y almacenaje.

Discover the new trends in order and storage

Découvrez les nouvelles tendances de l'ordre et du rangement

OPCIONAL:

TIRAS LED PARA INTERIOR DE CAJAS DE ARMARIO:

x1 TIRA LED /CAJA	205 Puntos
x2 TIRAS LED /CAJA	290 Puntos

PUERTAS CON PERFIL DE ALUMINIO - CRISTAL TEMPLADO:

x1 PTA CRISTAL PARSOL TEMPLADO	400 Puntos
x2 PTAS CRISTAL PARSOL TEMPLADO	800 Puntos

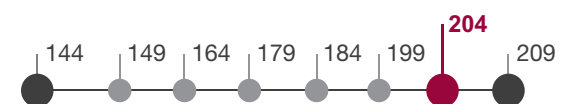
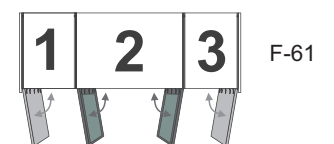

Color
Colour/Couleur

A05

Nature



Metálico
Metal/Métallique

A20

Ónix



Ilumina el dormitorio, da luz a tus sueños.

Illuminate the bedroom, give light to your dreams.

-
Illumine la chambre, donne de la lumière à tes rêves.

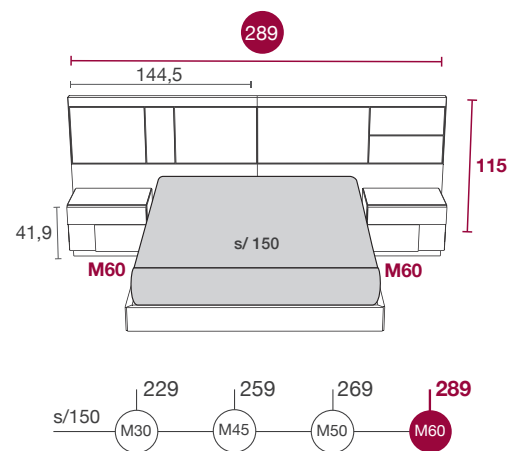

E101



Color
Colour/Couleur

K06

Teka



Detalle
Detail/Détail

K01

Blanco
White



Detalle 2
Detail/Détail

K11

Avellana



Metálico
Metal/Métallique

K21

Blanco

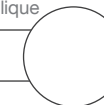

Líneas de luz para crear una geometría perfecta.

Light lines to create a perfect geometry.

Lignes de lumière pour créer une géométrie parfaite.

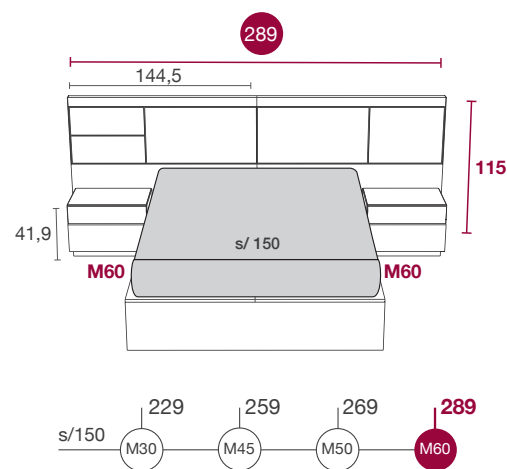

Mesitas/Bedside/Chevets Mod. MAX

E102



Color
Colour/Couleur

K04

Bambú



Detalle
Detail/Détail

K01

Blanco
White



Detalle 2
Detail/Détail

K13

Verde Té

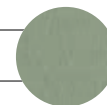

Metálico
Metal/Métallique

K21

Blanco

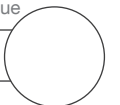

Un dormitorio cómodo y acogedor, un lugar donde descansar.

A comfortable bedroom, a place to rest.

-

Une chambre confortable, un endroit pour se reposer.

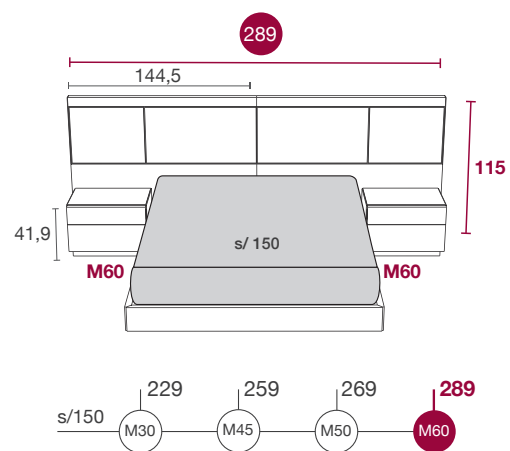

Mesitas/Bedsides/Chevets Mod. TOR

E103



Color
Colour/Couleur

K02

Fresno

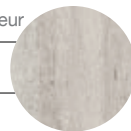

Detalle
Detail/Détail

K01

Blanco
White



Detalle 2
Detail/Détail

K12

Gris Fumé



Metálico
Metal/Métallique

K21

Blanco

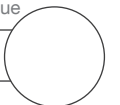

Este aro cama es ideal, dispone de una gran capacidad para almacenaje y un gran diseño.

This bedframe is ideal, has a large capacity for storage and a great design.

-
Ce cadre-lit est idéal, a une grande capacité de stockage et un excellent design.

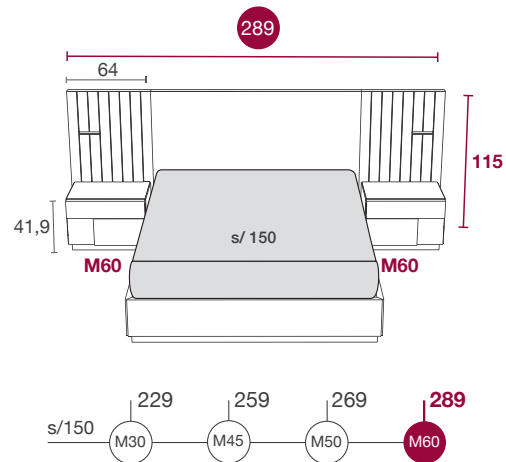

E104



Color
Colour/Couleur

K06

Teka



Detalle
Detail/Détail

K12

Gris Fumé



Metálico
Metal/Métallique

K20

Zafiro





Dos pequeños focos dan la luz necesaria para iluminar tu mesita.

Two small spotlights give the light needed to light your table.

-
Deux petits foyes donnent la lumière nécessaire pour éclairer votre table.

E104-d1 Detalle lateral
Lateral detail
Détail latéral



E104-d2 Detalle encaste del cabezal en el rodapié
 Detail of the adjust of the headboard on the plinth
 Détail de l'ajustement de la tête de lit sur le socle

Almacenaje para todos en este espacioso canapé.

Storage for everyone in this spacious canapé.

Stockage pour tout le monde dans ce canapé-lit spacieux.



E104-d3 Detalle del canapé abierto
 Detail open storage-bed
 Détail canapé-lit ouvert

Las líneas verticales del cabezal le dan un toque señorial al dormitorio que además se refuerza con el detalle de luz en cada ala del cabezal.

The vertical lines of the headboard give a manor touch to the bedroom, which is also reinforced with the detail of light in each wing of the headboard.

Les lignes verticales de la tête de lit donnent une touche manoir à la chambre qui est également renforcée avec le détail de la lumière dans chaque aile de la tête de lit.

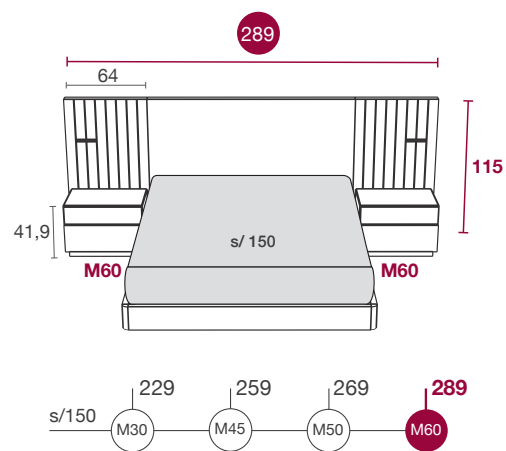

Mesitas/Bedsides/Chevets Mod. MAX

E105



Color
Colour/Couleur

K04

Bambú



Metálico
Metal/Métallique

K21

Blanco

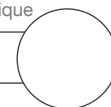

E106





Un color natural y sencillo que aporta elegancia al ambiente.

A natural and simple color that brings elegance to the ambient.

Une couleur naturelle et simple qui apporte de l'élégance à l'ambiance.

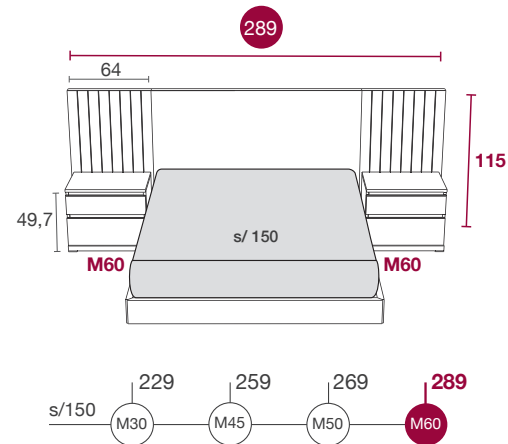

Color

Colour/Couleur

K05

Roble
Rock



Metálico

Metal/Métallique

K21

Blanco

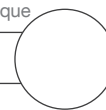



Mesitas y cómoda modelo KOS
Bedsides and Chest of drawers KOS model
Chevets et commode modèle KOS

El tirador de este modelo es un pequeño perfil metálico situado en la parte superior del cajón que le da elegancia al conjunto; puede elegir entre Blanco o Zafiro.

The handle of this model is a little metallic profile placed on the top of the drawer that provides elegance to the module; you can choose between Blanco or Zafiro.

La poignée de ce modèle est un petit profil métallique placé sur le dessus du tiroir qui fournit l'élégance au module; vous pouvez choisir entre Blanco ou Zafiro.



Mesitas y sintonieras modelo KOS
Bedsides and chiffoniers KOS model
Chevets et chiffonniers modèle KOS

El estante de madera y metal resalta con el color natural del cabezal, dándole un toque diferente.

The wooden and metal shelf highlights with the natural color of the headboard, giving it a different touch.

L'étagère en bois et en métal se souligne par la couleur naturelle de la tête, lui donnant une touche différente.

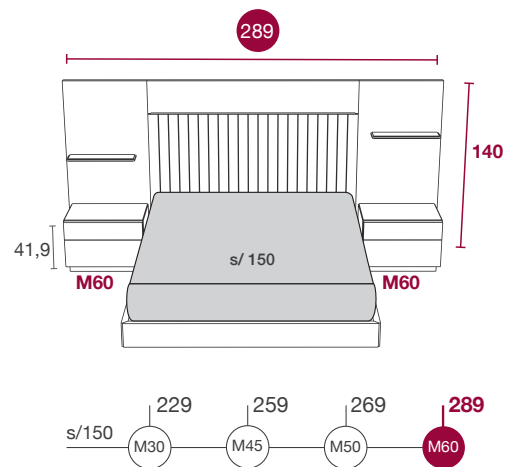

Mesitas/Bedsides/Chevets Mod. TOR

E107



Color
Colour/Couleur

K05

Roble
Rock

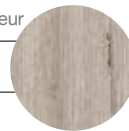

Detalle
Detail/Détail

K11

Avellana



Metálico
Metal/Métallique

K21

Blanco

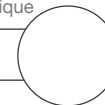

Una cama con capacidad extra, cuatro cajones y dos arcones para poder guardar todo lo que necesites.

A bed with extra capacity, four drawers and two chests to store everything you need.

Un lit avec une capacité supplémentaire, quatre tiroirs et deux coffres pour ranger tout ce que vous voulez.

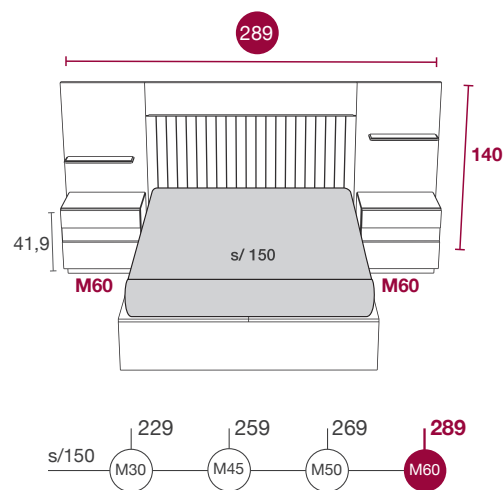

Mesitas/Bedside/Chevets Mod. MAX

E108



Color
Colour/Couleur

K04

Bambú



Detalle
Detail/Détail

K12

Gris Fumé



Metálico
Metal/Métallique

K20

Zafiro



El orden en el dormitorio es clave para crear un ambiente acogedor y armonioso.

The order in the bedroom is the key to create a cozy and harmonious atmosphere.

L'ordre dans la chambre est essentiel pour créer une atmosphère chaleureuse et harmonieuse



E108-d1 Detalle de los arcones y cajones abiertos
Detail of open chests and drawers
Détail des coffres et tiroirs ouverts



E108-d2 Vista de la cama abierta
Open bed view
Vue lit ouvert

La combinación de acabados claros consigue una atmósfera fresca y serena, que además aporta calidez.

The combination of clear finishes achieves a cool and serene atmosphere, which also brings warmth.

La combinación de finitions claires permet d'obtenir une atmosphère fraîche et sereine, qui apporte également de la chaleur.

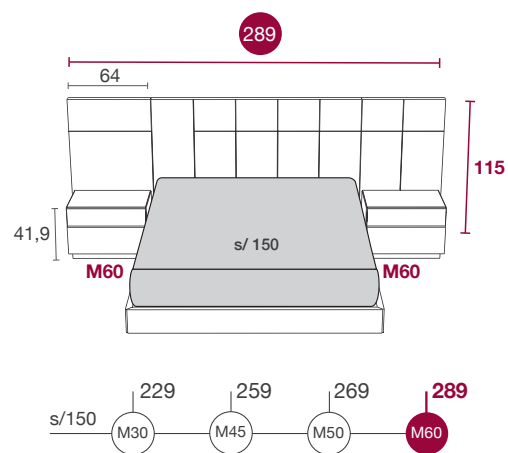

Mesitas/Bedsides/Chevets Mod. TOR

E109



Color
Colour/Couleur

K04

Bambú



Detalle
Detail/Détail

K12

Gris Fumé



Con una adecuada elección de los detalles, el espacio cobra vida.

With a proper choice of details, the space comes alive.

- Avec un bon choix de détails, l'espace s'anime.

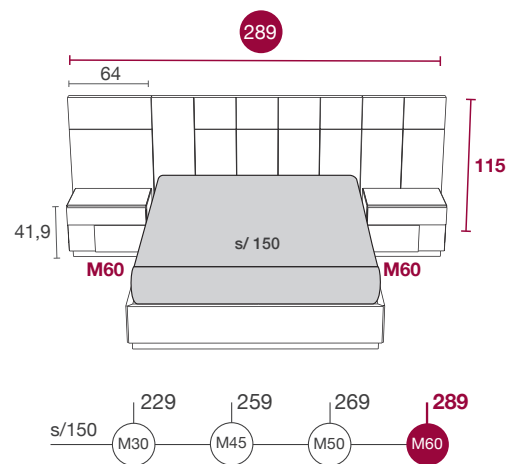

E110



Color
Colour/Couleur

K05

Roble
Rock



Detalle
Detail/Détail

K01

Blanco
White



Detalle 2
Detail/Détail

K11

Avellana



Un dormitorio donde se aprecia el estilo natural de la madera con el toque industrial del metal.

A bedroom where you can appreciate the natural style of wood with the industrial touch of metal.

- Une chambre où vous pouvez apprécier le style naturel du bois avec la touche industrielle du métal.

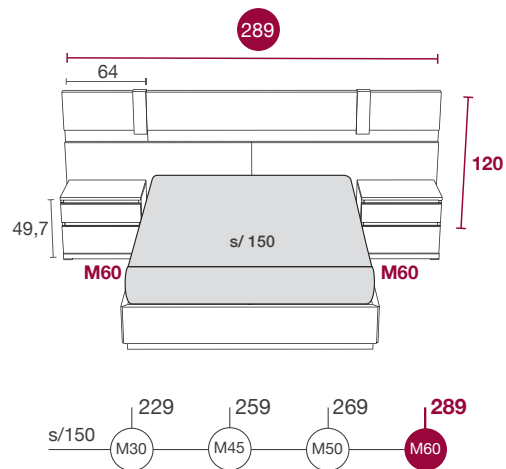

E111



Color
Colour/Couleur

K03

Borneo

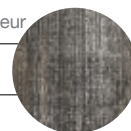

Detalle
Detail/Détail

K12

Gris Fumé



Metálico
Metal/Métallique

K20

Zafiro





E111-d1 Detalle en Borneo con Gris Fumé y metal Zafiro
 Detail in Borneo colour with Gris Fumé and Zafiro metal
 Détail en couleur Borneo et Gris Fumé avec métallique Zafiro

Combina los diferentes acabados y obtén diferentes posibilidades

Combine the different finishes and get different possibilities.

Combinez les différentes finitions et obtenez différentes possibilités.



E111-d2 Detalle del canapé abierto
 Detail open storage-bed
 Détail canapé-lit ouvert



E111-d3 Detalle canapé en posición para hacer la cama
 Detail storage-bed in position to do the bed
 Détail canapé-lit en position pour faire le lit

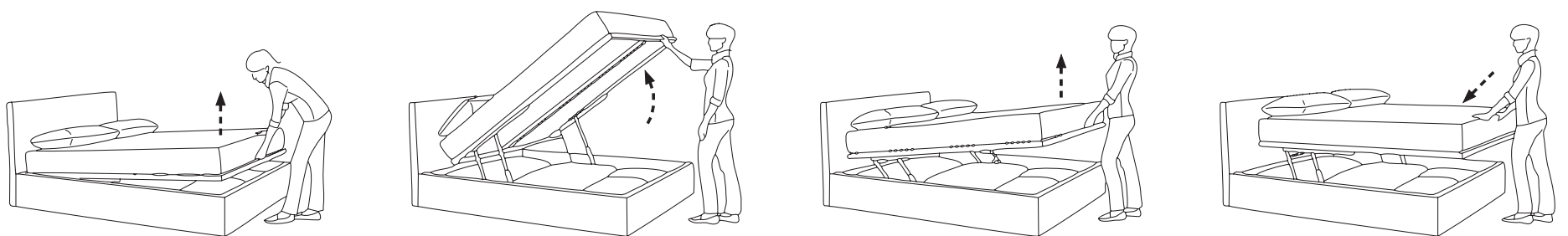

E112



Color
Colour/Couleur

K04

Bambú



Detalle
Detail/Détail

K01

Blanco
White



Metálico
Metal/Métallique

K21

Blanco

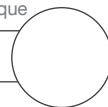



Modernidad y organización, juntas en un mismo espacio.

Modernity and organization, together in the same space.

Modernité et organisation, ensemble dans le même espace.

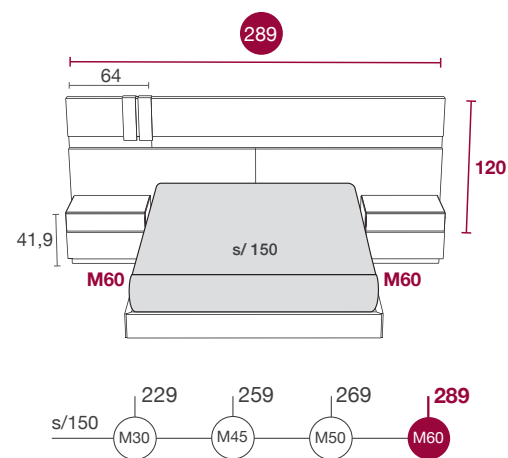

Mesitas/Bedsides/Chevets Mod. MAX



E112-d1 Detalle en color Bambú con Blanco White y metálico Blanco
Detail in Bambú colour with Blanco White and Blanco metal
Détail en couleur Bambú avec Blanco White et métallique Blanco

**Madera y metal,
dos materiales
nobles que por
muchos años que
pasen, no pasan
de moda. Por se-
parado tienen una
personalidad pro-
pia y llena de fuer-
za, aunque muy
diferente entre sí.
Contrarios pero
complementarios.**

Wood and metal, two noble materials that for many years that pass, do not go out of style. Separately they have a personality of their own and full of strength, although very different from each other. Contrary but complementary.

-
Le bois et le métal, deux matières nobles qui, pendant de nombreuses années, ne se démodent pas. Séparément, ils ont une personnalité propre et pleine de force, bien que très différents les uns des autres. Contraire mais complémentaire.

El detalle metálico zafiro del cabezal combina con el tono de los detalles de la mesita y del cabezal.

The Zafiro metallic detail of the headboard combines with the tone of the details of the bedside table and the headboard.

Le détail en métal Zafiro de la tête de lit se combine avec le ton des détails du chevet et de la tête de lit.

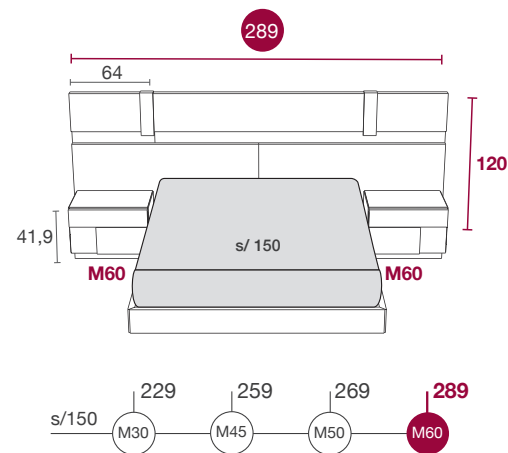

E113



Color
Colour/Couleur

K02

Fresno



Detalle
Detail/Détail

K12

Gris Fumé



Metálico
Metal/Métallique

K20

Zafiro







E113-d1 Detalle en Fresno con Gris Fumé y metálico Zafiro
Detail in Fresno with Gris Fumé and Zafiro metal
Détail en couleur Fresno avec Gris Fumé et métallique Zafiro

El dormitorio, un espacio fundamental para nuestra vida nocturna donde la iluminación y la decoración son elementos clave.

The bedroom, a fundamental space for our nightlife where lighting and decoration are key elements.

La chambre, un espace fondamental pour notre vie nocturne où l'éclairage et la décoration sont des éléments clés.

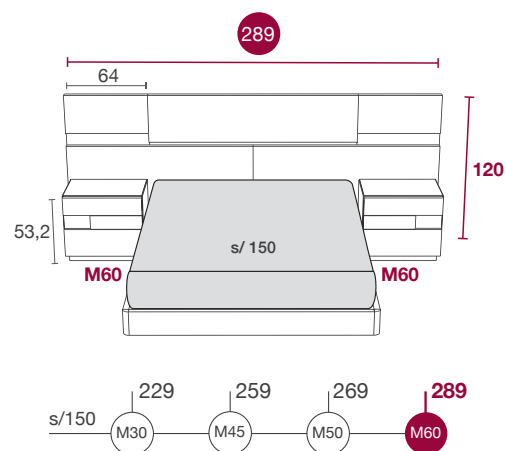

Color
Colour/Couleur

K06

Teka



Detalle
Detail/Détail

K01

Blanco
White



E114





E114-d1 Detalle en Teka con Blanco White
Detail in Teka with Blanco White
Détail en couleur Teka avec Blanco White

Con una buena elección en la combinación del color, obtienes la identidad en tu espacio.

With a good choice in the colour combination,
you get the identity in your space.

-

Avec un bon choix dans la combinaison des
couleurs, vous obtenez l'identité dans votre
espace.



Mesitas y cómoda modelo ZEN
Bedsides and Chest of drawers ZEN model
Chevets et commode modèle ZEN



Mesitas y sinfonieres modelo ZEN
Bedsides and chiffoniers ZEN model
Chevets et chiffonniers modèle ZEN

Un cabezal con múltiples posibilidades para un dormitorio totalmente personalizado.

A headboard with multiple possibilities for a fully customized bedroom.

- Une tête de lit avec plusieurs possibilités pour une chambre entièrement personnalisée.

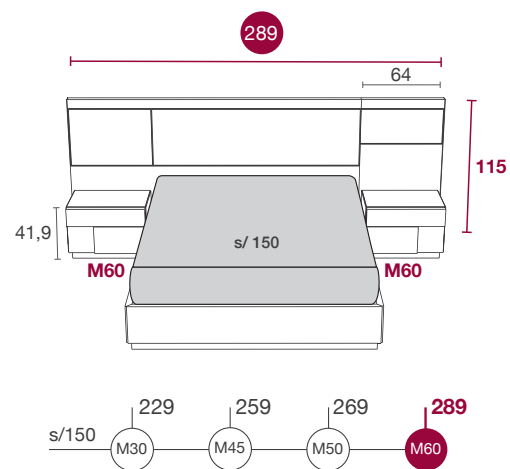



E115

Color
Colour/Couleur

K04

Bambú



Detalle
Detail/Détail

K12

Gris Fumé



Detalle 2
Detail/Détail

K01

Blanco
White



Metálico
Metal/Métallique

K21

Blanco

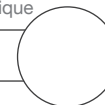

E116



Color
Color/Couleur

K01

Blanco
White

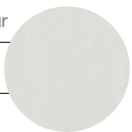

Detalle
Detail/Détail

K05

Roble
Rock



Metálico
Metal/Métallique

K21

Blanco

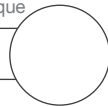



La ventaja de este aro suspendido es que es muy práctico y seguro, aportando modernidad al conjunto.

The advantage of this suspended bedframe is that it is very practical and safe, bringing modernity to the bedroom.

L'avantage de cette cadre-lit suspendue est qu'elle est très pratique et sûre, apportant modernité à l'ensemble.

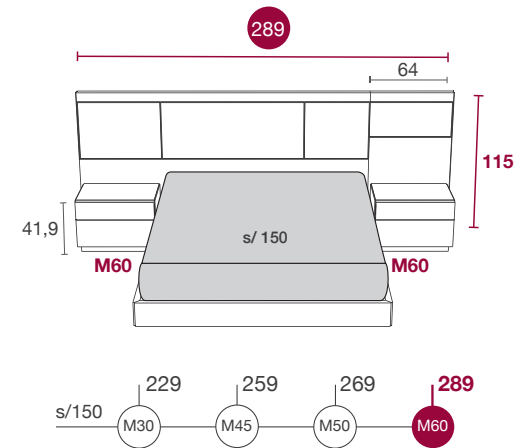

Mesitas/Bedsides/Chevets Mod. TOR

Un espacio diseñado para el confort y la tranquilidad.

A space designed for comfort and tranquility.

Un espace conçu pour le confort et la tranquillité.

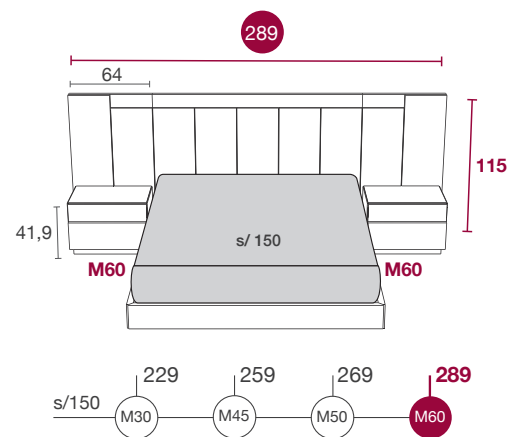

Mesitas/Bedsides/Chevets Mod. TOR

E117



Color
Colour/Couleur

K05

Roble
Rock



Detalle
Detail/Détail

K01

Blanco
White



Detalle 2
Detail/Détail

K11

Avellana



Un dormitorio totalmente funcional: aro cama suspendido para una mejor limpieza, mesitas de 3 cajones y cómoda a juego para un almacenaje extra.

A fully functional bedroom: suspended bed for a better cleaning, bedside 3 drawers and matching chest of drawers for extra storage.

Une chambre totalement fonctionnelle: lit suspendu pour un meilleur nettoyage, chevets 3 tiroirs et commode assortie pour un rangement supplémentaire.

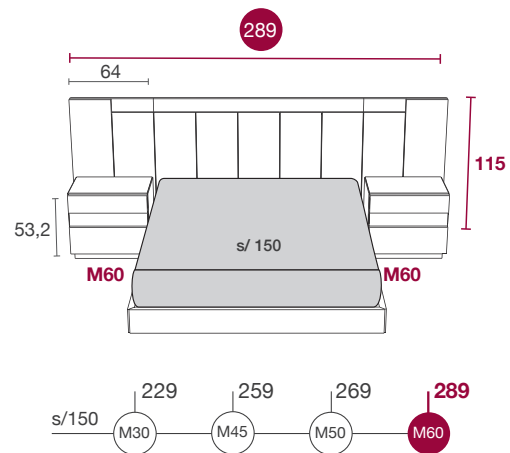

Mesitas/Bedsides/Chevets Mod. MAX

E118



Color

Colour/Couleur

K04

Bambú



Detalle

Detail/Détail

K12

Gris Fumé



E119



Color
Colour/Couleur

K05

Roble
Rock



Detalle
Detail/Détail

K12

Gris Fumé



Metálico
Metal/Métallique

K20

Zafiro

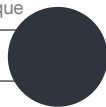

Formas que se relacionan, funcionalidad y estética en perfecta sintonía.

Ways that relate, functionality and aesthetics in perfect harmony.

-
Des manières qui se rapportent, fonctionnalité et esthétique en parfaite harmonie.

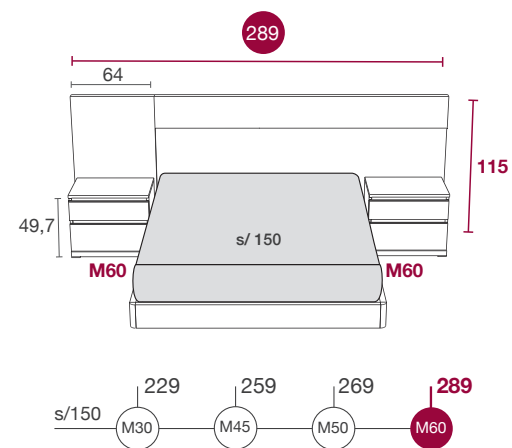

Diseño y capacidad infinita, dos sifonieres de 6 cajones cada uno para poder guardar todas tus cosas.

Design and infinity capacity, two chiffoniers with 6 drawers each to store all your things.

Un design et une capacité infinis, deux chiffonniers avec 6 tiroirs chacune pour ranger toutes vos affaires.

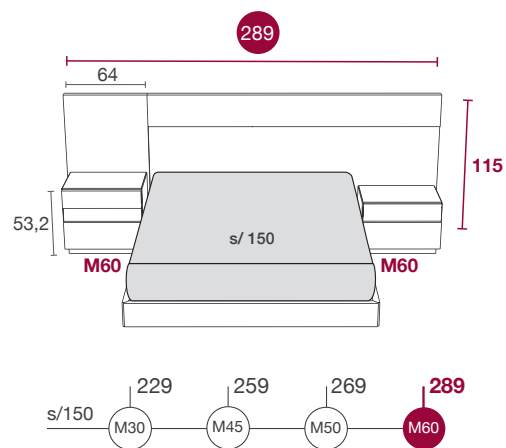

Mesitas/Bedsides/Chevets Mod. MAX

E120



Color
Colour/Couleur

K04

Bambú



Los volúmenes no pasan desapercibidos, generan contornos que marcan la diferencia.

The volumes do not go unnoticed, they generate contours that makes the difference.

-

Les volumes ne passent pas inaperçus, ils génèrent des contours qui font la différence.



E120-d1 Detalle en color Bambú
Detail in Bambú colour
Détail en couleur Bambú

Cada uno de los elementos del conjunto propone una solución adaptada al estilo de vida actual, en la parte izquierda, descubrimos un conjunto de espejo vertical y un sinfonier.

The advantage of this suspended bedframe is that it is very practical and safe, bringing modernity to the bedroom.

L'avantage de cette cadre-lit suspendue est qu'elle est très pratique et sûre, apportant modernité à l'ensemble.

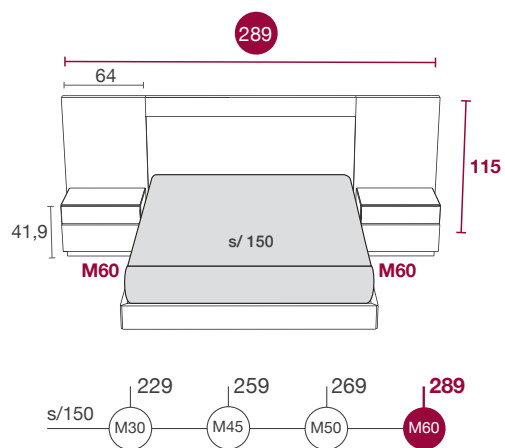

Mesitas/Bedsides/Chevets Mod. MAX

E121



Color
Colour/Couleur

K02

Fresno



Detalle
Detail/Détail

K01

Blanco
White





E122



Color
Colour/Couleur

K05

Roble
Rock



Detalle
Detail/Détail

K01

Blanco
White



Metálico
Metal/Métallique

K21

Blanco

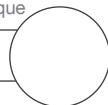



Este cabezal es el alma de tu dormitorio: el diseño y la iluminación harán tu dormitorio muy acogedor.

This headboard is the soul of your bedroom: the design and lighting will make your bedroom very cozy.

Cette tête de lit est l'âme de votre chambre : le design et l'éclairage rendront votre chambre très confortable.

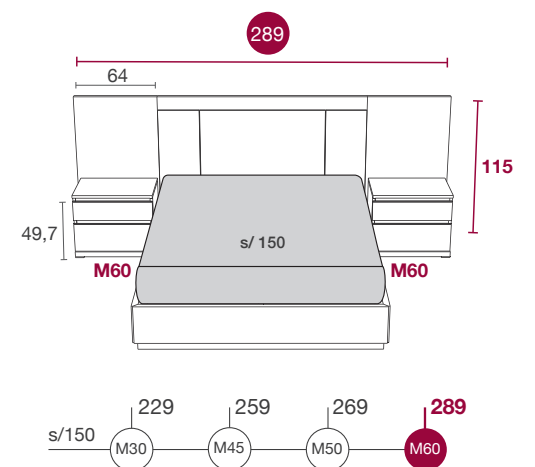

E123



Mesitas/Bedsides/Chevets Mod. TOR

El cabezal, un detalle único que dará diseño y estilo a tu habitación.

The headboard, a unique detail that will give design and style to your bedroom.

- La tête de lit, un détail unique qui donnera du style et design à votre chambre.

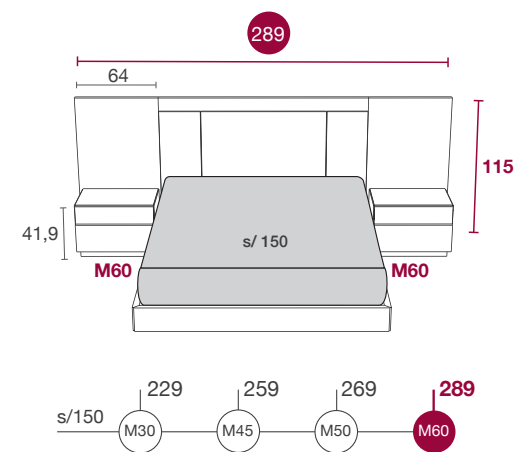

Color
Colour/Couleur

K12

Gris
Fumé

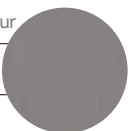

Detalle
Detail/Détail

K04

Bambú



Detalle 2
Detail/Détail

K01

Blanco
White

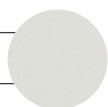

Modelo con líneas elegantes, aristas de caja ingletadas, efecto sin sobre y frentes de diferentes grosores.

Model with elegant lines, mitered box edges, effect without top and fronts of different thicknesses.

-
Modèle avec des lignes élégantes, bords des caisses en onglet, effet sans surface et fronts d'épaisseurs différentes.



Mesitas y cómoda modelo MAX
Bedsides and Chest of drawers MAX model
Chevets et commode modèle MAX



Mesitas y sinfonieres modelo MAX
Bedsides and chiffoniers MAX model
Chevets et chiffonniers modèle MAX

E124



Color
Colour/Couleur

K05

Roble
Rock



Detalle
Detail/Détail

K12

Gris Fumé



Metálico
Metal/Métallique

K21

Blanco

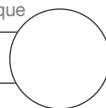



Un dormitorio actual y elegante. Juvenil y adaptable.

A modern and elegant bedroom. Youthful and adaptable.

Une chambre moderne et élégante. Jeune et adaptable.

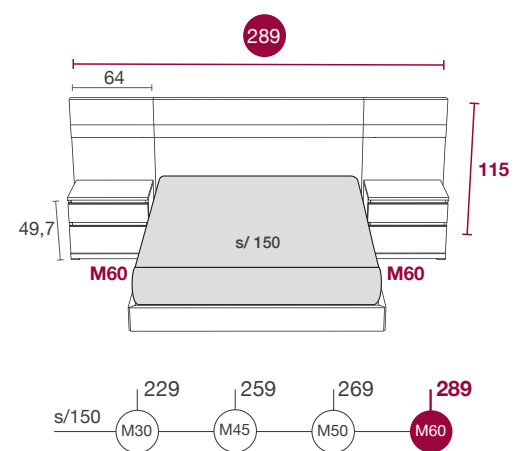

Los detalles marcan la diferencia: luz en el ala del cabezal y auto-freno en los cajones de la mesita.

The details make the difference: light in the wing of the headboard and self-brake in the drawers of the bedside table.

-
Les détails font la différence : la lumière dans l'aile de la tête de lit et l'auto-frein dans les tiroirs de la table nuit.



E124-d1 Detalle en Roble Rock con Gris Fumé y metal Blanco
Detail in Roble Rock with Gris Fumé and Blanco metal
Détail en couleur Roble Rock et Gris Fumé avec métallique Blanco

Dormitorio y estudio 2 en 1. Trabajar o descansar en un mismo espacio.

Bedroom and study 2 in 1. Work or rest in the same space.

Chambre et étude 2 en 1. Travaillez ou reposez-vous dans le même espace.

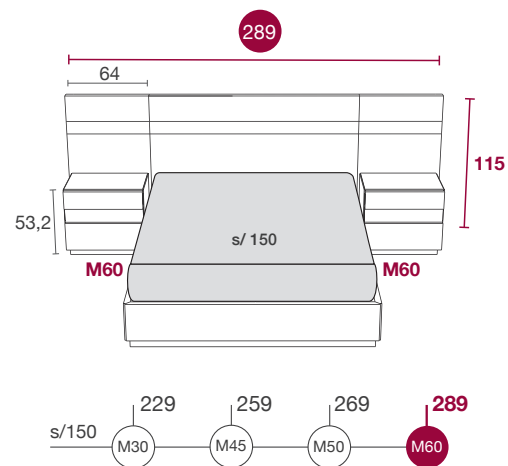

Mesitas/Bedsides/Chevets Mod. MAX

E125



Color
Colour/Couleur

K02

Fresno



Detalle
Detail/Détail

K12

Gris Fumé



Metálico
Metal/Métallique

K20

Zafiro





E125-d1 Detalle mesa de estudio en color Fresno y metálico Zafiro
Detail study table in Fresno colour and Zafiro metal
Détail table d'étude en couleur Fresno et métallique Zafiro

**Un escritorio que
encaja a la perfec-
ción con el espacio.
Proporciona un
espacio extra para
poder trabajar en el
dormitorio.**

A desk that fits perfectly with space. It provides an extra space to work in the bedroom.

-

Un bureau qui s'intègre parfaitement avec l'espace. Il fournit un espace supplémentaire pour travailler dans la chambre.

**Un cabezal atrevido,
para una
persona
aventurera.**

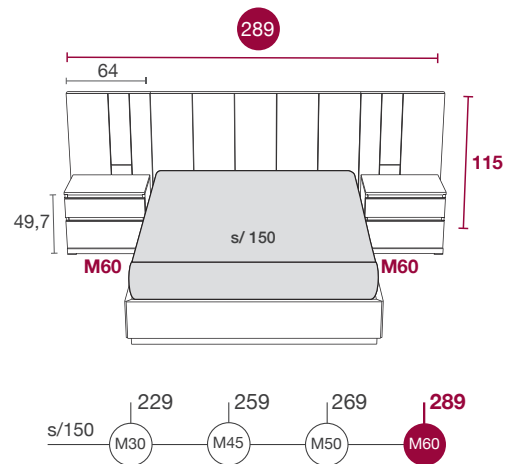

E126



Color
Colour/Couleur

K06

Teka



Detalle
Detail/Détail

K01

Blanco
White



Metálico
Metal/Métallique

K21

Blanco

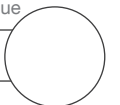

E127



Color
Colour/Couleur

K04

Bambú



Detalle
Detail/Détail

K01

Blanco
White



Detalle 2
Detail/Détail

K11

Avellana





Un dormitorio lleno de vida, de sueños y de alegría.

A bedroom full of life, dreams and joy.

Une chambre pleine de vie, de rêves et de joie.

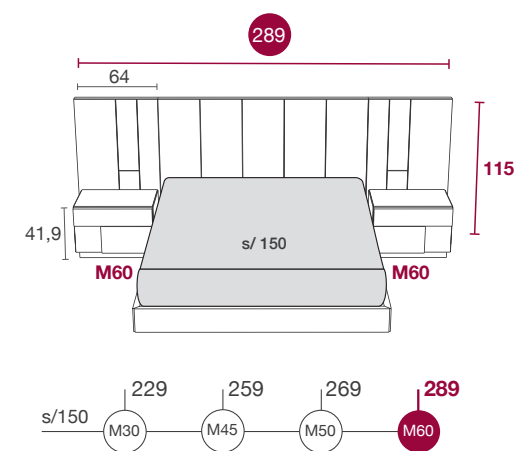

Menos es más, la elegancia de lo singular.

Less is more, the elegance of the unique.

-
Moins est plus, l'élégance du singulier.

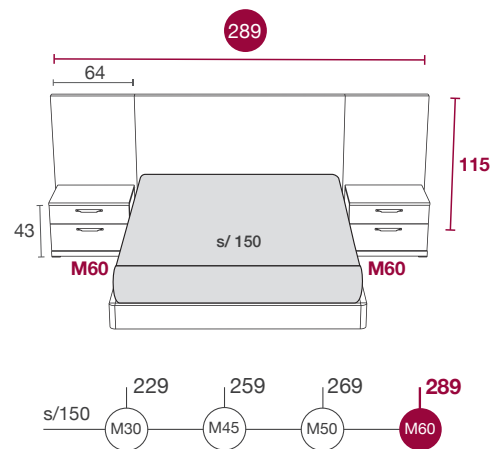

E128



Color
Color/Couleur

K01

Blanco
White

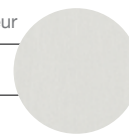

Detalle
Detail/Détail

K06

Teka



Metálico
Metal/Métallique

K21

Blanco

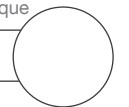

Este modelo dispone de un tirador metálico práctico; puede elegir entre dos colores diferentes. Además, tiene opción de sistema de apertura Push (sin tirador).

This model has a metallic practical handle; you can choose between two different colours. Also has option of Push system (without handle).

Ce modèle a une poignée pratique en métal ; vous pouvez choisir entre deux couleurs différentes. A également l'option du système Push (sans poignée).



Mesitas y cómoda modelo NEO

Bedsides and Chest of drawers NEO model
Chevets et commode modèle NEO



Mesitas y sinfonieres modelo NEO
Bedside tables and chests of drawers NEO model
Chevets et chiffonniers modèle NEO

E129



Color
Colour/Couleur

K05

Roble
Rock



Detalle
Detail/Détail

K12

Gris Fumé



Detalle
Detail/Détail

K01

Blanco
White

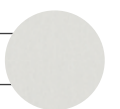

E130



Color
Color/Couleur

K01

Blanco
White

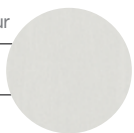

Detalle
Detail/Détail

K06

Teka





La combinación de un color natural con un color neutro, es un acierto asegurado.

The combination of a natural color with a neutral color is a guaranteed success.

- La combinaison d'une couleur naturelle avec une couleur neutre est un succès garanti.

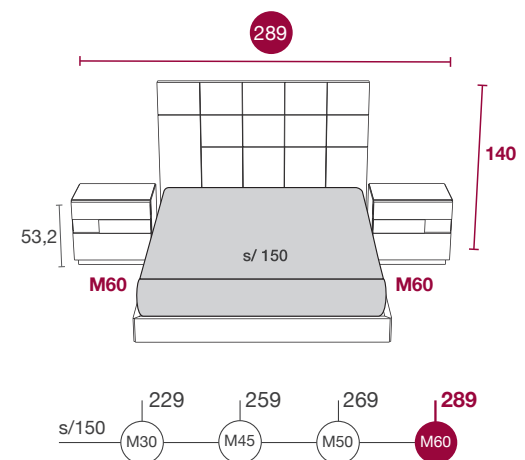

La mesa de estudio es el complemento perfecto para crear espacios versátiles y funcionales

The study table is the perfect complement to create versatile and functional spaces.

La table d'étude est le complément idéal pour créer des espaces polyvalents et fonctionnels.

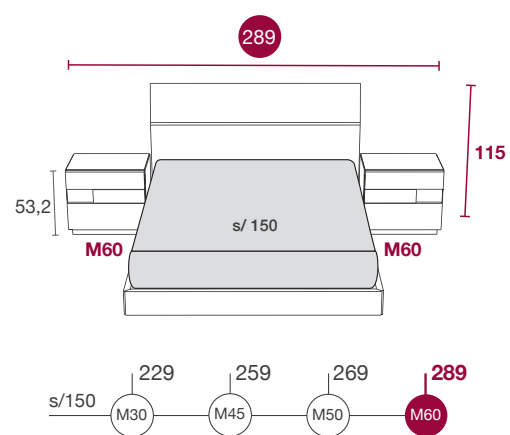

E131



Color
Colour/Couleur

K06

Teka



Detalle
Detail/Détail

K12

Gris Fumé



Metálico
Metal/Métallique

K20

Zafiro



La elección de los detalles está en ti, te ofrecemos una gran diversidad en combinaciones.

The choice of details is in you, we offer you a great diversity in combination.

Le choix des détails est en vous, nous vous offrons une grande diversité de combinaisons.

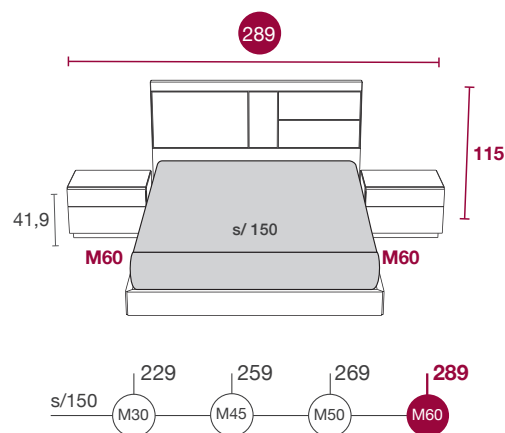

Mesitas/Bedsides/Chevets Mod. TOR

E132



Color
Colour/Couleur

K04

Bambú



Detalle
Detail/Détail

K01

Blanco
White



Detalle 2
Detail/Détail

K12

Gris Fumé



Metálico
Metal/Métallique

K21

Blanco

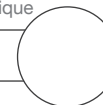



Mesitas y cómoda modelo TOR
Bedsides and Chest of drawers TOR model
Chevets et commode modèle TOR



Mesitas y cómoda modelo TOR
Bedsides and Chest of drawers TOR model
Chevets et commode modèle TOR

Líneas marcadas y nuevos colores, una apuesta segura para un dormitorio actual.

Marked lines and new colors, a safe bet for a current bedroom.

Lignes marquées et nouvelles couleurs, un pari sûr pour une chambre actuelle.

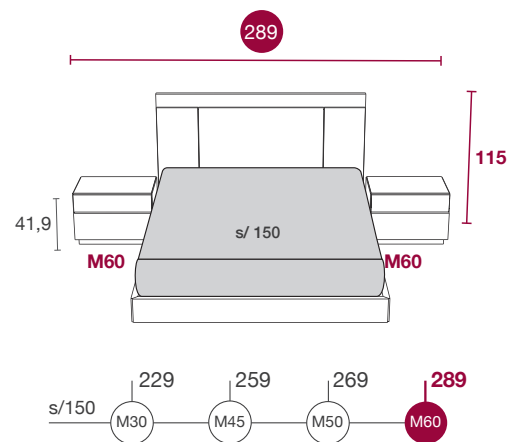

Mesitas/Bedsides/Chevets Mod. TOR

E133



Color
Colour/Couleur

K03

Borneo

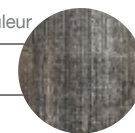

Detalle
Detail/Détail

K12

Gris Fumé

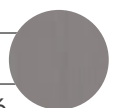

E134



Color
Colour/Couleur

K05

Roble
Rock



Detalle
Detail/Détail

K11

Avellana

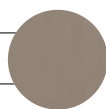

Metálico
Metal/Métallique

K21

Blanco

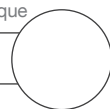



La colección Esenzia 3.5 ofrece una amplia selección de muebles ideales para conseguir ambientes actuales.

The Esenzia 3.5 collection offers a wide selection of furniture ideal for current ambients.

La collection Esenzia 3.5 offre un large choix de meubles idéaux pour les ambiances actuels.

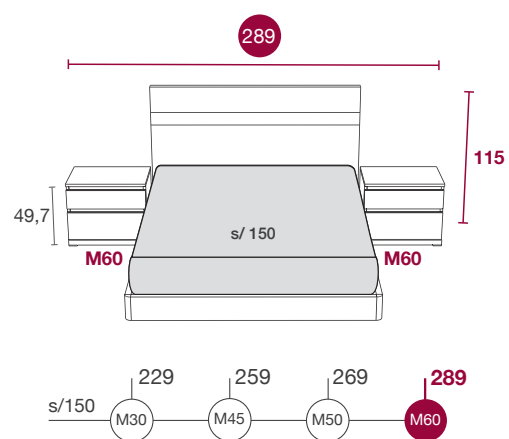

Los armarios de dos puertas correderas son ideales tanto por espacio como por distribución interior.

Wardrobes with two sliding doors are ideal both for space and for interior distribution.

Les armoires de deux portes coulissantes sont idéales à la fois pour l'espace et pour la distribution intérieure.



Color
Colour/Couleur

K03

Borneo

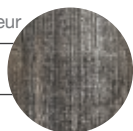

Detalle
Detail/Détail

K12

Gris Fumé



Metálico
Metal/Métallique

K20

Zafiro

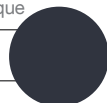

AR01



AR02



Color

Colour/Couleur

K06

Teka



Metálico

Metal/Métallique

K20

Zafiro

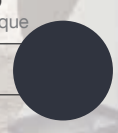

Los armarios en tonos más claros hacen el espacio más grande.

Wardrobes in more light tones make the space bigger.

Les armoires en couleurs plus claires font l'espace plus grand.

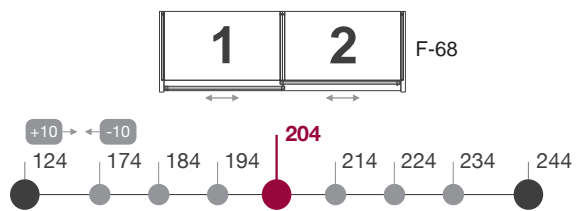

Color
Color/Couleur

K01

Blanco
White

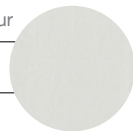

Metálico
Metal/Métallique

K21

Blanco

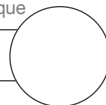

Color
Colour/Couleur

K02

Fresno

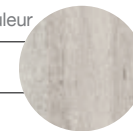

Metálico
Metal/Métallique

K20

Zafiro



Armarios que se adaptan a tu estilo.

Wardrobes that adapt to your style.

Armoires qui s'adaptent à votre style.



Color
Colour/Couleur

K05

Roble
Rock



Detalle
Detail/Détail

K11

Avellana

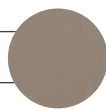

Metálico
Metal/Métallique

K21

Blanco

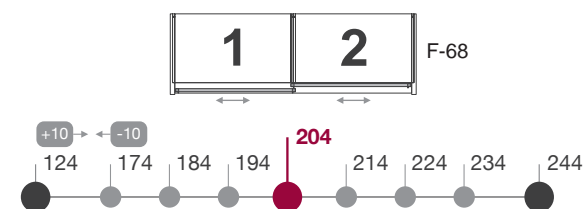
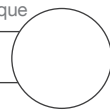

AR06



Color
Colour/Couleur

K02

Fresno



Detalle
Detail/Détail

K12

Gris Fumé



Metálico
Metal/Métallique

K21

Blanco

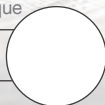



Detalle interior de armario
Detail of wardrobe's interior
Détail de l'intérieur de l'armoire

Rentabiliza al máximo el espacio. Los cajones, los estantes y las perchas proporcionan espacio y capacidad.



Maximize the space. Drawers, shelves and hangers bar provide space and capacity.

-
Maximiser l'espace. Tiroirs, étagères et barres offrent de l'espace et de la capacité..



Detalle del raíl de la puerta corredera
Detail of the sliding door rail
Détail du raíl de la porte coulissante

Detalle del cajón y guías
Detail of the drawer and guides
Détail du tiroir et la guide

La combinación de colores genera espacios personalizables.

The colour combination generates customizable spaces.

La combinación de colores genera espacios personalizables.

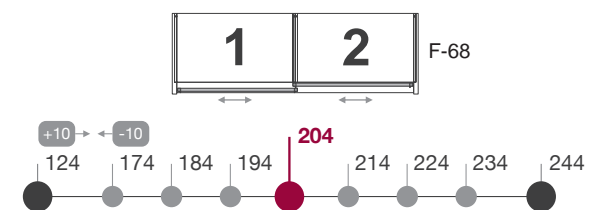

Color
Colour/Couleur

K03

Borneo

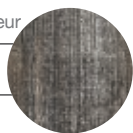

Detalle
Detail/Détail

K12

Gris Fumé



Metálico
Metal/Métallique

K20

Zafiro

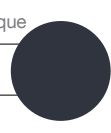

Color
Colour/Couleur

K06

Teka

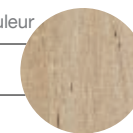

Metálico
Metal/Métallique

K20

Zafiro

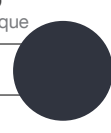

AR09



Color
Colour/Couleur

K04
Bambú



Detalle
Detail/Détail

K01
Blanco
White



Metálico
Metal/Métallique

K21
Blanco

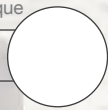

AR10



Color Colour/Couleur	Detalle Detail/Détail	Metálico Metal/Métallique
K06 Teka	K12 Gris Fumé	K21 Blanco

Las puertas de este armario pueden combinarse en diferentes colores.

The doors of this wardrobe can be combined in different colors.
-
Les portes de cette armoire peuvent être combinées en différentes couleurs.

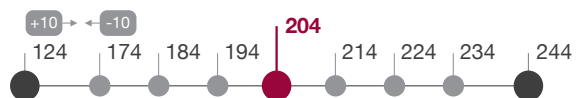

Color
Colour/Couleur

K04
Bambú



Detalle 2
Detail/Détail

K01
Blanco
White



Metálico
Metal/Métallique

K21
Blanco

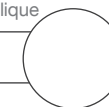



Detalle de interior de armario
Detail of wardrobe's interior
Détail de l'intérieur de l'armoire

Configura el interior del armario en relación a tus necesidades.

Configure the wardrobe interior in relation to your needs.

Configurez l'intérieur de l'armoire en fonction de vos besoins.

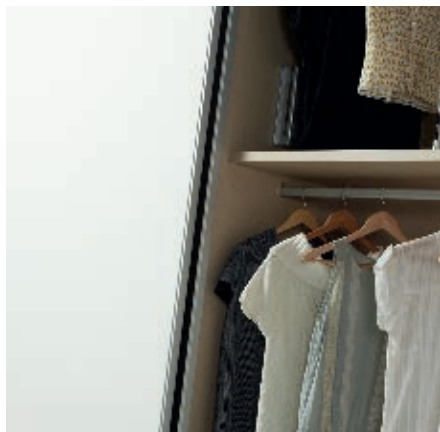

Detalle colgador percha abatible
Detail of pull down wardrobe rail
Détail de la barre de penderie escamotable



Detalle del pantalonero
Detail of trouser rack
Détail du porte-pantalons



AR12

Color
Color/Couleur

K01

Blanco
White



Detalle
Detail/Détail

K12

Gris Fumé



Metálico
Metal/Métallique

K21

Blanco



Estas puertas con detalle de color le dan un toque diferente al armario.

These doors with colour detail bring a different touch to the wardrobe

Ces portes avec des détails de couleur apportent une touche différente à l'armoire

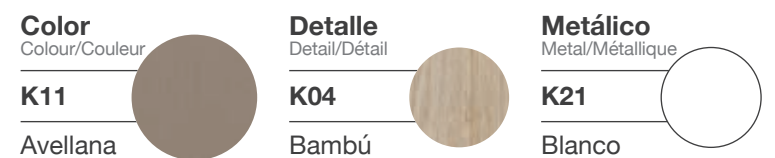
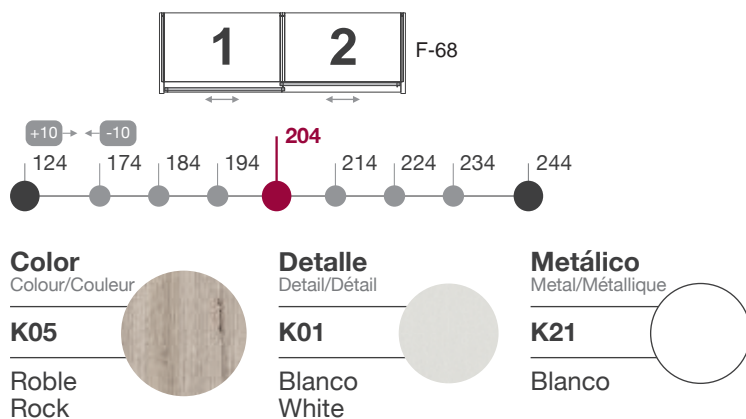

Mantén el orden en tu armario con un interior personalizado.



Keep order in your wardrobe with a custom interior.

- Gardez l'ordre dans votre armoire avec un intérieur personnalisé.

Detalle interior de armario Teka

Detail of wardrobe's interior in Teka
Détail de l'intérieur de l'armoire Teka

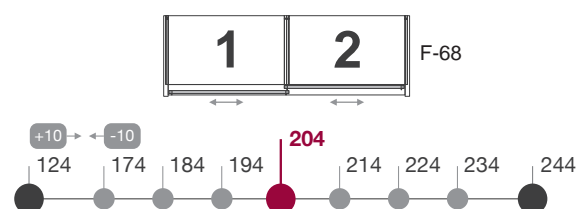

Color
Colour/Couleur

K04
Bambú



Detalle
Detail/Détail

K01
Blanco
White



Metálico
Metal/Métallique

K21
Blanco

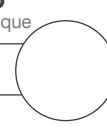

AR15



AR16

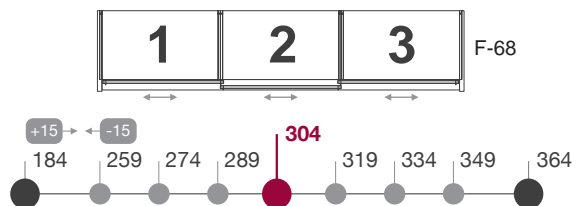

Color
Colour/Couleur

K05

Roble
Rock



Metálico
Metal/Métallique

K21

Blanco

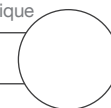



AR17



Las puertas con espejo aportan valor añadido, ya que otorgan otra funcionalidad al armario.

The mirrored doors provide added value, as they provide another functionality to the wardrobe.

Les portes en miroir apportent une valeur ajoutée, car elles offrent une autre fonctionnalité à l'armoire.

Color
Colour/Couleur

K03

Borneo

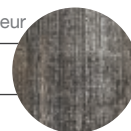

Detalle
Detail/Détail

K04

Bambú



Metálico
Metal/Métallique

K20

Zafiro



AR18

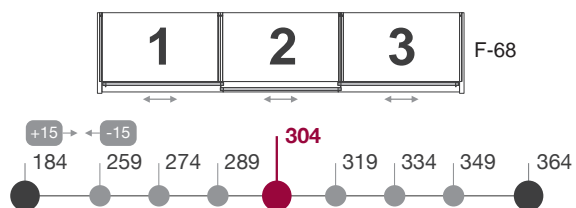

Color
Colour/Couleur

K04
Bambú



Detalle
Detail/Détail

K12
Gris Fumé



Metálico
Metal/Métallique

K21
Blanco

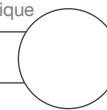



Ganar espacio para ganar calidad de vida.

Save space to win life quality.

-
Économiser l'espace pour gagner qualité de vie.

AR19



Las puertas correderas llevan auto-freno para un cierre seguro y suave.

Sliding doors carry auto-brake for a safe and soft closing

Les portes coulissantes sont équipées d'un système d'auto-frein pour une fermeture sûre et douce.

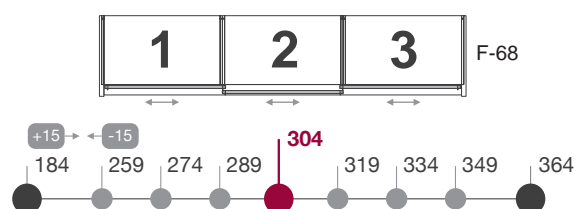

Color
Colour/Couleur

K02
Fresno



Detalle
Detail/Détail

K01
Blanco
White



Metálico
Metal/Métallique

K21
Blanco

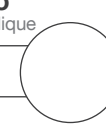

AR20



Color
Colour/Couleur

K04

Bambú



Detalle
Detail/Détail

K11

Avellana

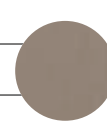

Metálico
Metal/Métallique

K21

Blanco

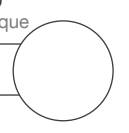

Los armarios de puertas batientes son perfectos para adaptarse a cualquier tipo de espacio.

These wardrobes are perfect to adapt to any type of space.

Les armoires de portes battantes sont parfaites pour s'adapter à tout type d'espace.

Color
Colour/Couleur

K05

Roble
Rock



Metálico
Metal/Métallique

K21

Blanco

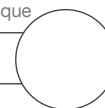

AR21



AR22



Los armarios de seis puertas batientes tienen una capacidad de almacenaje extra.

The six-door wardrobes have an extra storage capacity.

Les armoires de six portes battantes ont une capacité de stockage supplémentaire.

Color
Colour/Couleur

K05

Roble
Rock



Metálico
Metal/Métallique

K20

Zafiro

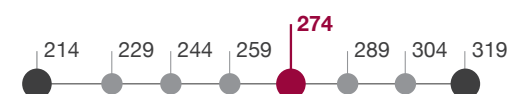
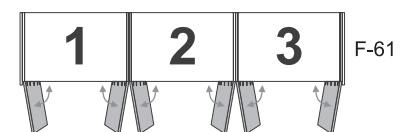

AR23

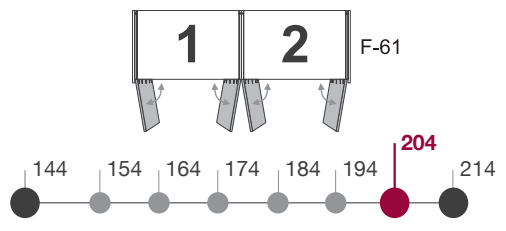

Color
Colour/Couleur

K04
Bambú



Metálico
Metal/Métallique

K20
Zafiro

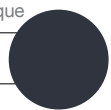

Los tonos claros acentúan la amplitud la estancia.

Light tones accentuate the amplitude of the room.

Les tons clairs accentuent l'amplitude de la chambre.



Color
Color/Couleur

K01

Blanco
White

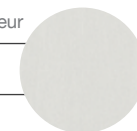

Metálico
Metal/Métallique

K21

Blanco

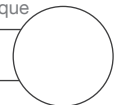

Estas puertas con moldura estilizan el armario; además llevan un pequeño tirador en el lateral de la moldura para hacerte más fácil la apertura y el cierre.

These doors with molding stylize the wardrobe; they also have a small handle on the side of the molding to make opening and closing easier.

Ces portes avec moulures stylisent l'armoire; Ils ont également une petite poignée sur le côté de la moulure pour faciliter l'ouverture et la fermeture.



Color
Colour/Couleur

K06

Teka

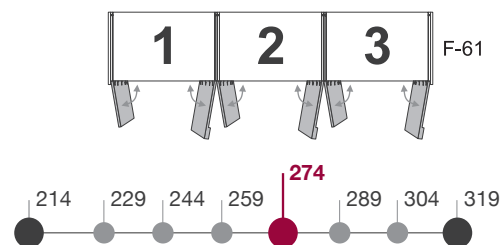

AR25



AR26



Los colores más oscuros y naturales le dan un toque rústico al armario.

Darker and more natural colours give a rustic touch to the wardrobe.

Les couleurs plus sombres et plus naturelles donnent une touche rustique à l'armoire.



AR26-d1 Detalle de la moldura de la puerta

Detail of the door molding
Détail de la moulure de la porte

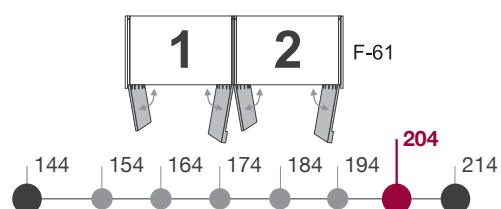

Color
Colour/Couleur

K05
Roble
Rock



Detalle
Detail/Détail

K11
Avellana



AR27



Color
Colour/Couleur
K12
Gris Fumé

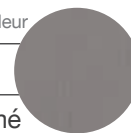

Detalle
Detail/Détail
K03
Borneo

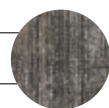

AR28





Organizarse es mucho más fácil con un armario batiente de gran capacidad

Organizing is so easier with a large-capacity wardrobe.

L'organisation est plus facile avec une grande armoire avec beaucoup capacité.



AR31-d1 Detalle del perfil de la puerta
Detail of the door profile
Détail du profile de la porte

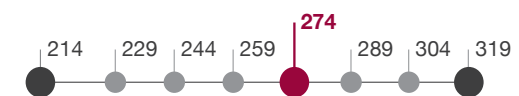
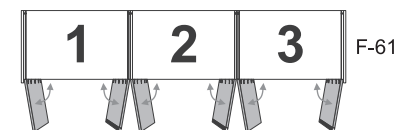

Color
Colour/Couleur

K04
Bambú



Metálico
Metal/Métallique

K21
Blanco

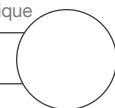

AR29

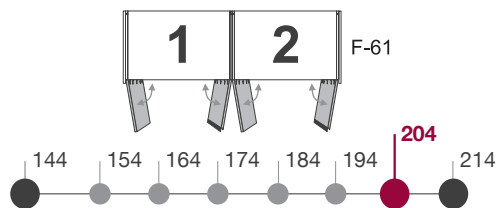

Color
Colour/Couleur

K06

Teka



Metálico
Metal/Métallique

K20

Zafiro



AR30



Color
Color/Couleur

K01

Blanco
White

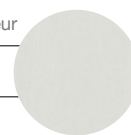

Metálico
Metal/Métallique

K21

Blanco

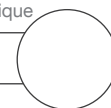

El vestidor, el espacio ideal para disfrutar de tu ropa. Organiza y optimiza el espacio de una manera ilimitada.

The dressing, the ideal space to enjoy your clothes. Organize and optimize the space in an unlimited way.

L'habilleur, l'espace idéal pour profiter de vos vêtements. Organisez et optimisez l'espace de manière illimitée.



Color
Colour/Couleur

K04

Bambú





Un mueble de gran capacidad para tu dormitorio.

The composition accentuates its horizontality with spacious modules that create sensations of more amplitude.

La composition souligne son horizontalité avec des modules spacieux qui créent un sentiment de plus grande amplitude.



Color
Colour/Couleur

K06

Teka



Metálico
Metal/Métallique

K20

Zafiro

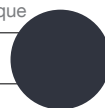



Interiores predefinidos

Predefined interiors / Intérieurs prédéfinis

Hemos creado unos interiores predefinidos para facilitar la selección del diseño del armario. Puede personalizarlo con ilimitadas opciones, escogiendo de los dos tipos de estructuras Base.

We have created pre-defined interiors to facilitate the selection of the wardrobe design. You can customize it with unlimited options, choosing from the two types of base structures.

Nous avons créé des intérieurs prédéfinis pour faire plus facile le dessin de l'armoire. Vous pouvez modifier selon différents goûts avec options illimitées, choisissant des deux différents caisses base.

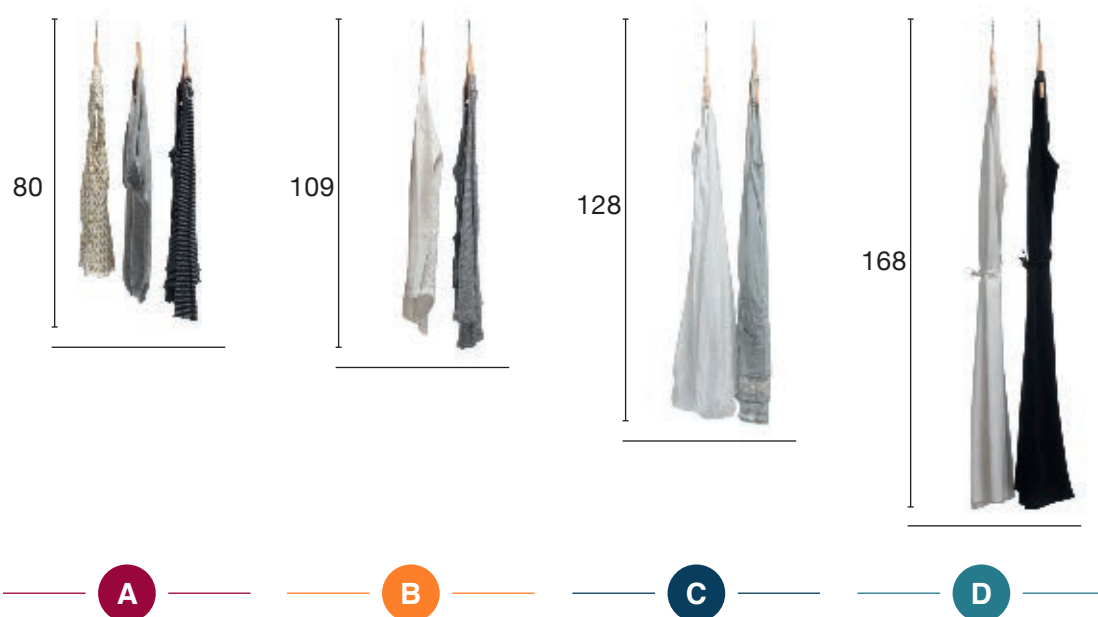

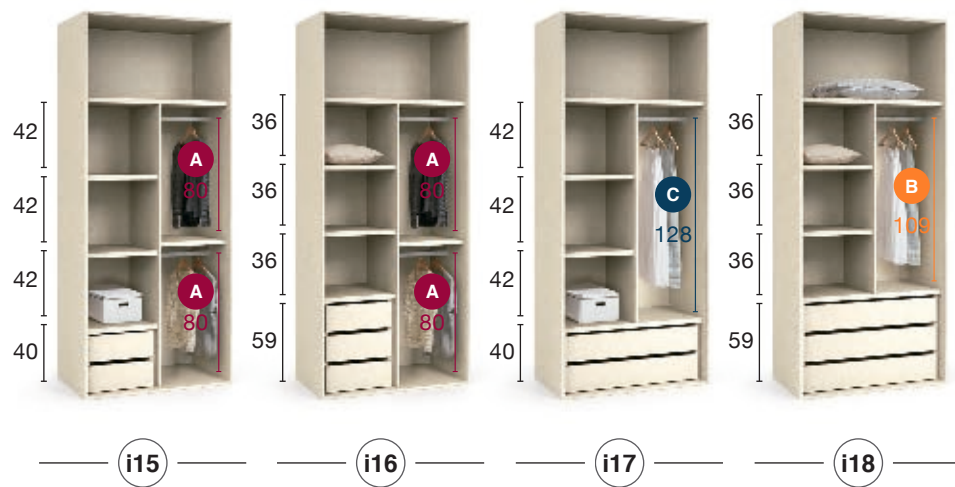
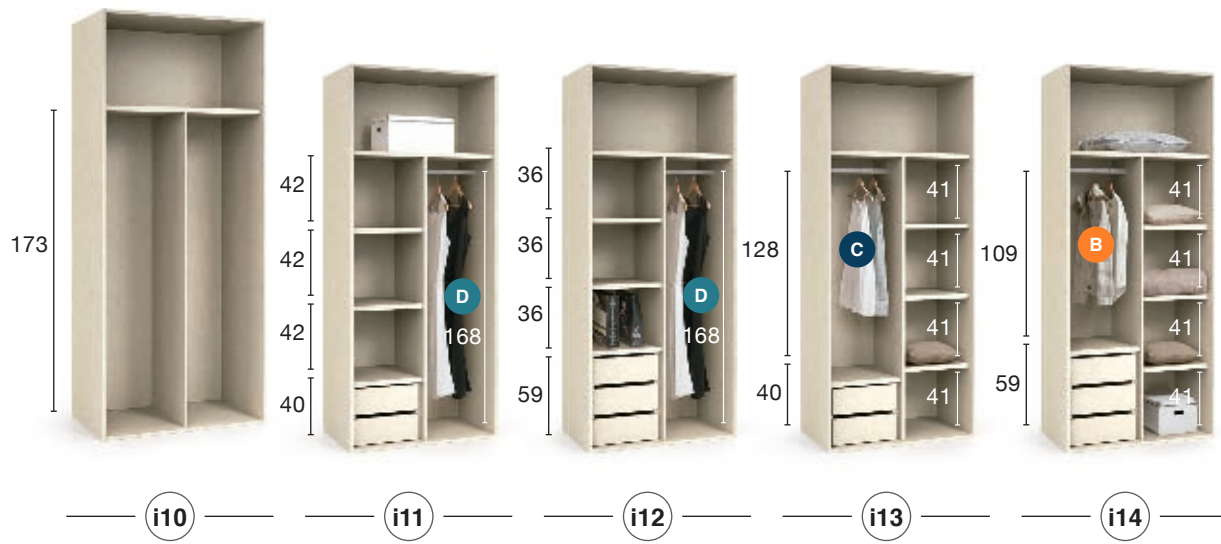

Muestras de Colores

Colour samples / Échantillons des couleurs

El programa permite combinar los colores naturales con colores neutros de detalle para crear espacios exclusivos y elegantes. Utiliza el color a tu gusto.

The program allows combining the natural colors with neutral colors of detail to create exclusive and elegant spaces. Use the colour to your liking.

-

Le programme combine des couleurs naturelles avec des détails de couleurs neutres pour créer des espaces uniques et élégants. Utilisez la couleur à votre goût.

Colores

Colours / Couleurs



K01 Blanco White



K02 Fresno



K03 Borneo



K04 Bambú



K05 Roble Rock



K06 Teka



K11 Avellana



K12 Gris Fumé



K13 Verde Té



K14 Azul Manhattan

Metálicos

Metal / Métallique



K20 Zafiro



K21 Blanco

Créditos:

Diseño de Producto:

Joan Barrera y Baixmoduls

Fotografía:

Carlos Gutiérrez

Diseño Gráfico:

WETE

Fotomecánica e Impresión:

Vanguard Gràfic

Patentes:

Los modelos de Paneles TV y los complementos metálicos están Patentados.

All TV Panels and metallic complements are patented.
Tous les Panneaux TV et accessoires en métal sont brevetés.

Aviso Legal:

Baixmoduls S.L. es titular de todos los derechos de propiedad intelectual e industrial del presente catálogo, así como del mobiliario incluido en el mismo, y, del mismo modo, de los accesorios y sistemas que componen este último. En este sentido, queda terminantemente prohibida, sin autorización expresa y fehaciente de su titular, su total o parcial reproducción, comunicación y/o distribución con fines comerciales o lucrativos, su modificación y/o alteración, así como cualquier otro acto de explotación del presente catálogo o del mobiliario, accesorios y sistemas, que lo componen. Cualquier vulneración de los citados derechos será perseguida ante los tribunales, civiles o penales, con cuantos medios legales resulten de aplicación. La presente advertencia legal exime a **Baixmoduls S.L.** de requerir la cesación en su conducta ilegal, con carácter previo a la interposición de acciones judiciales, a aquellas personas físicas o jurídicas que, directa o indirectamente, vulneren los citados derechos de propiedad; quedando, en consecuencia, **Baixmoduls S.L.** en libertad para interponer cuantas acciones correspondan en Derecho contra las mismas, sin previo aviso, tan pronto tenga conocimiento de cualquier vulneración de su propiedad intelectual e industrial.

esenzia 3.5
dormitorios · armarios
Bedrooms · Wardrobes / Chambres · Armoires

www.baixmoduls.com 